



ambition

rimless metal 8 base

a661, a662, a663, a664,
a665 3-pcs. mounting,
clip-on a526

support your vision — adidas.com/eyewear

a661



a662



a663



a664



8 base

NEW 8 new adult shapes for sport minded individuals who want to show their attitude in business as well as in leisure time

NEW Hybrid Memory Hinge™ for automatic and exceptionally comfortable fit

NEW highly valuable, metallic-like logopart

NEW Performance Steel™ inlay

NEW temples can be shortened easily

NEW also wearable as sunglasses (with tinted lenses)

temples made of our patented lightweight and comfortable material SPX™

straight temples for a sporty looking design

SPX™ temples adjustable to different head shapes

frame comes in its own hardcase incl. adidas cleaning cloth

NEU 8 neue Brillenformen für Erwachsene, die Ihre sportliche Haltung gern im Geschäftsleben sowie in der Freizeit zum Ausdruck bringen möchten

NEU Hybrid Memory Hinge™ für besonders komfortablen Sitz

NEU hochwertiges, metallisch anmutendes Logo

NEU Performance Steel™ Bugeleinlage

NEU Bügel lassen sich leicht verkürzen

NEU auch tragbar als Sonnenbrille (mit getönten Gläsern)

Bügel gefertigt aus unserem patentierten, leichten und komfortablen Material SPX™

gerade Bügel für ein sportlich aussehendes Design

SPX™ Bügel für verschiedene Kopfformen anpassbar

Rahmen wird in eigenem Brillenetui mit adidas Reinigungstuch geliefert

NOUVEAU 8 nouveaux modèles pour adultes, dédiés aux adeptes de sport qui désirent afficher leur état d'esprit au travail et dans leurs loisirs

NOUVEAU Hybrid Memory Hinge™ s'adaptant automatiquement pour offrir un ajustement exceptionnellement confortable

NOUVEAU logo d'aspect métallique de grande qualité

NOUVEAU branche armée en Performance Steel™

NOUVEAU branches facilement raccourçissables

NOUVEAU utilisables également comme lunettes de soleil (avec verres teintés)

NOUVEAU branches en SPX™, notre matériau breveté ultraléger et confortable

branches droites pour un look sportif

branches en SPX™ ajustables aux différentes anatomies

Les montures sont livrées avec un étui rigide ainsi qu'une chamoisine adidas



a661 00 6050
rhodium/lime

a662 50 6054
black/black

a663 40 6053
chocolate/chocolate

a664 60 6057
ruthenium/blue

General glazing information::

- Lensformers in 2 sizes available
- 3pcs mount a665 is available (only for producing 8 base frames)
- Glazing limit max. 6,5mm lens thickness

Allgemeine Verglasungsinformation:

- Formscheiben in 2 Größen erhältlich
- Garnitur a665 erhältlich;
- bitte diese Garnitur nur zum Fertigen von 8 base Brillen verwenden
- Verglasungslimit: maximal 6,5 mm Glasstärke

Informations générales sur le montage:

- Un modèle de verre est disponible
- Le montage en 3 pièces a665 est disponible (seulement pour la production de montures base 8)
- Mise à la vue: épaisseur des verres: 6,5 mm maximum

Options for adjusting the eyewear to individual wearers:

Inclination

- Make sure to fix the lens in the temporal area before inclination
- Inclination metal hinge (note: only use parallel action pliers with plastic jaws) (see figure 1)

Temples

- Marks on the inside of the temples (5 mm spacing) make it easier to shorten the temples (see figure 2-7)
- The temples can be adjusted to the shape of the head and ears (see figure 8-9) (without heating)
- Temples are available as spare parts

Individuelle Anpassungsmöglichkeiten der Brille an den Träger:

Inklination

- Temporale Glasbefestigung fixieren
- Inklinierbares Metallscharnier (Achtung: nur mit einer Haltezange mit Kunststoffbacken, in paralleler Maulstellung, inklिनieren) (siehe Abbildung 1)

Bügel

- Markierungen an der Bügelinnenseite (Abstände 5 mm) vereinfachen das Kürzen des Bügels (siehe Abbildungen 2-7)
- Bügel an Kopfform und Ohrkontur anpassbar (siehe Abbildungen 8-9) (ohne Anwärmen)
- Bügel als Ersatzteil erhältlich

Options de réglage personnalisé des lunettes:

Inclinaison

- Assurez-vous de bien fixer le verre au niveau de la charnière avant de rabattre les branches
- Charnière métallique inclinable (attention: utilisez uniquement des pinces parallèles à mâchoires en plastique) (voir figure 1)

Branches

- Les Branches peuvent être facilement raccourcies grâce aux marques espacées de 5 mm sur leur face interne. (voir figure 2-7)
- Les branches peuvent être adaptées à la morphologie (tête et oreilles) (voir figure 8-9)
- Des branches de rechange peuvent être fournies

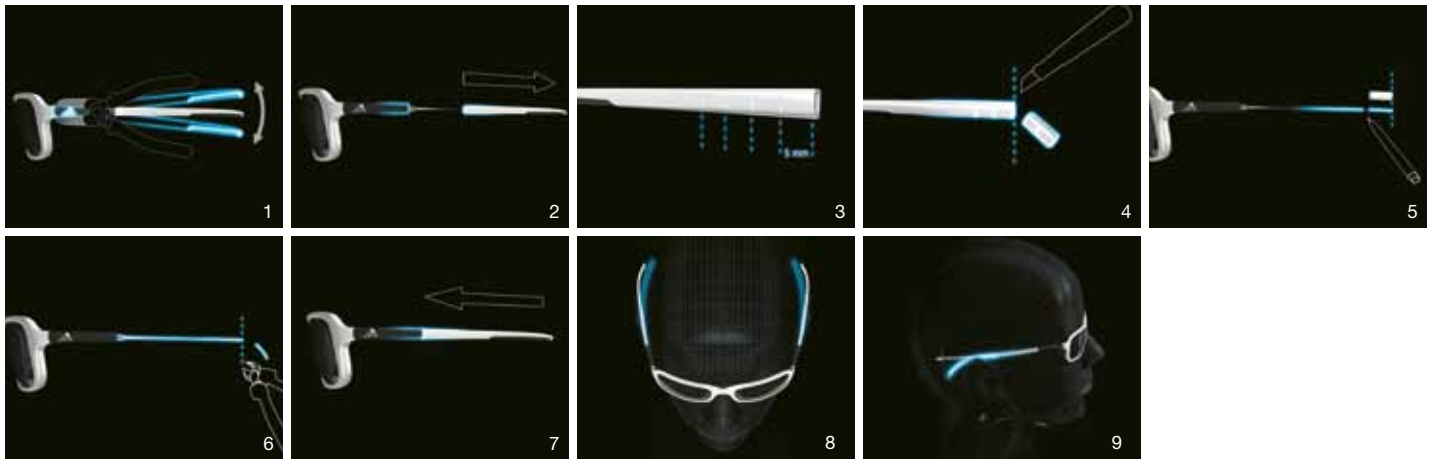

3-pcs. mounting
3-teilige Garnitur
montage en 3 pièces

a665

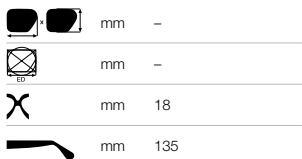

spare temple in 150 mm available

colours



a665 00 6050
rhodium/lime

a665 50 6054
black/black



a665 40 6053
chocolate/chocolate

a665 60 6057
ruthenium/blue





a661 00 6050 rhodium/lime

	small (lens former only)	large
 mm	57 x 29 (1461 mm ²)	59 x 31 (1565 mm ²)
 mm	60	62
 mm		18
 mm		135
 °		2 x 19

clip-on available (both sizes)
a526 00 a661 grey-green polarized

polarized

spare parts a661

- BC 606 temples
- GK 219 temple tips
- SR 270 K3 temple joint screw
- SP 92 GL nose pads
- STG 81 showing lens 8 base
- BLS 58 glazing pins
- PL 13 adidas cleaning cloth
- BA 833-7 lug



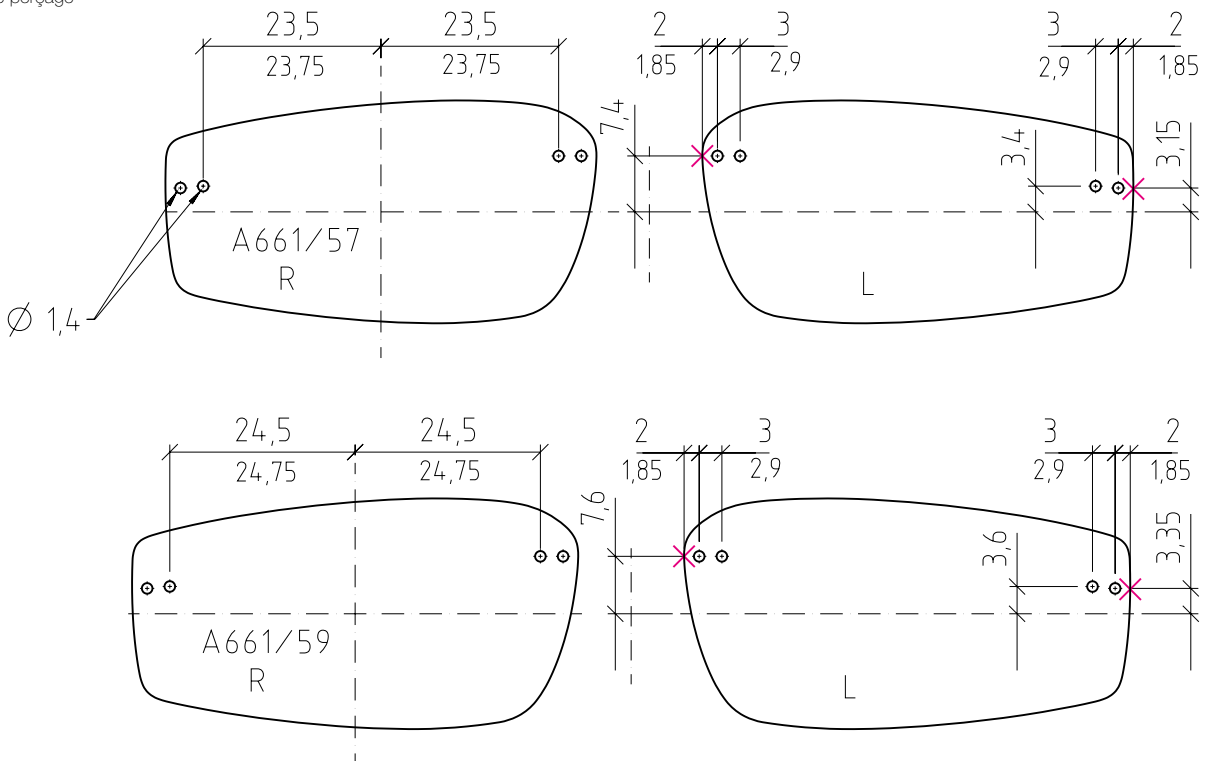

drilling coordinates
Bohrkoordinaten
cotes de perçage





a662 50 6054 black/black

	small	large (lens former only)
 mm	57 x 32 (1636 mm ²)	59 x 34 (1753 mm ²)
 mm	62	65
 mm	18	
 mm	135	
 °	2 x 19	

 **clip-on available (both sizes)**
a526 00 a662 grey-green polarized

polarized

spare parts a662

- BC 606 temples
- GK 219 temple tips
- SR 270 K3 temple joint screw
- SP 92 GL nose pads
- STG 81 showing lens 8 base
- BLS 58 glazing pins
- PL 13 glazing pins
- BA 833-7 adidas cleaning cloth lug



drilling coordinates
Bohrkoordinaten
cotes de perçage

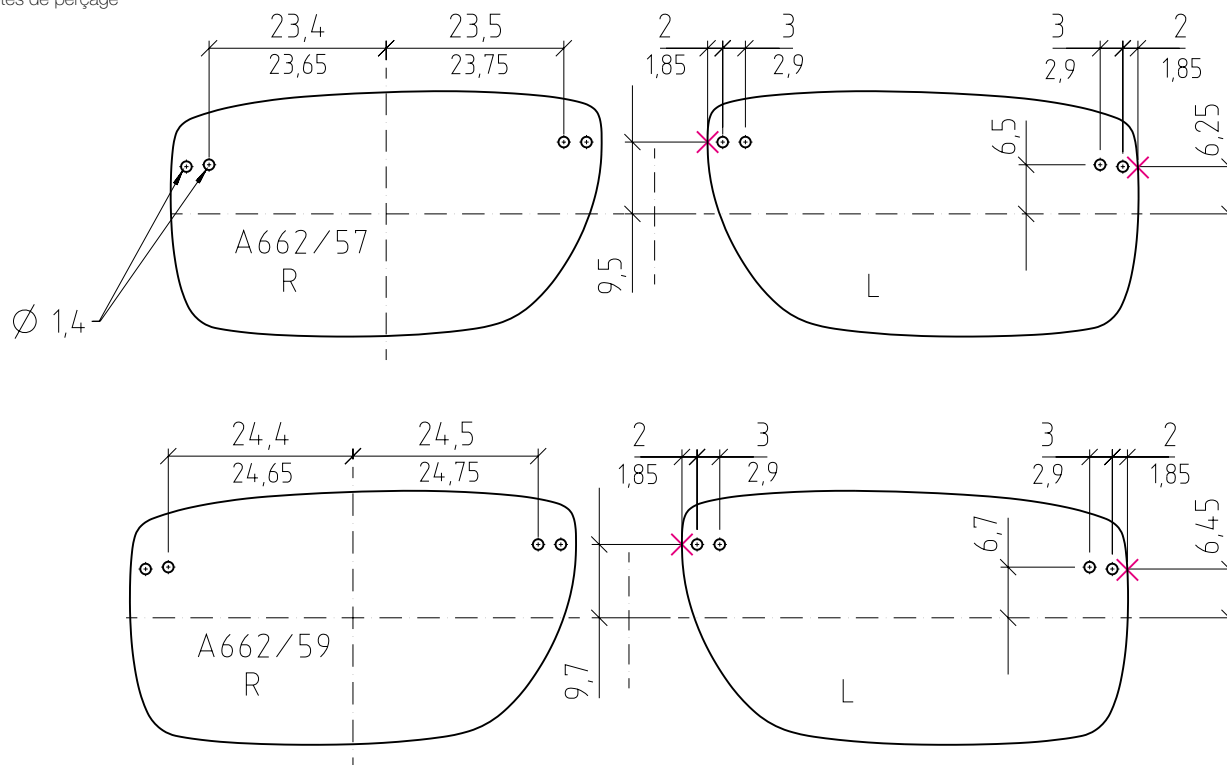



a663 40 6053 chocolate/chocolate

	small	large (lens former only)
	mm 56 x 32 (1525 mm ²)	58 x 33 (1636 mm ²)
	mm 59	61
	mm 18	
	mm 135	
	° 2 x 19	
	clip-on available (both sizes) a526 00 a663 grey-green polarized	

polarized

spare parts a663

- BC 606 temples
- GK 219 temple tips
- SR 270 K3 temple joint screw
- SP 92 GL nose pads
- STG 81 showing lens 8 base
- BLS 58 glazing pins
- PL 13 adidas cleaning cloth
- BA 833-7 lug



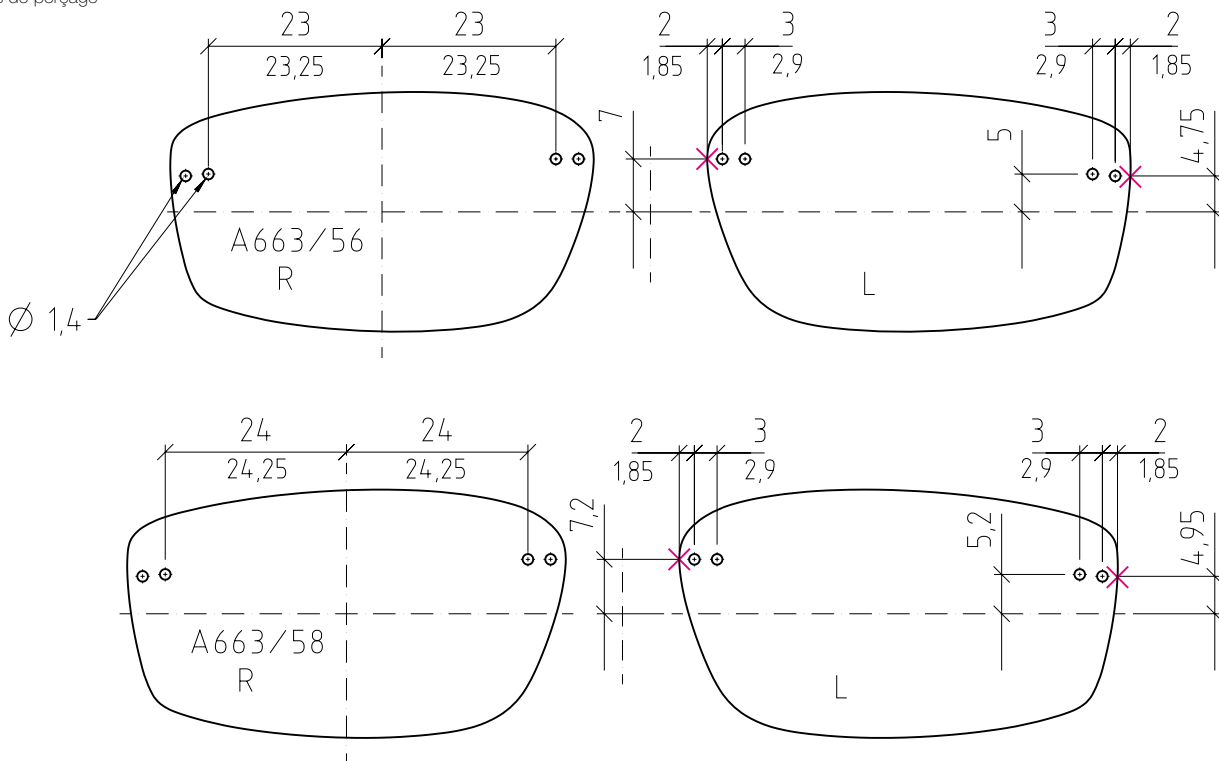

drilling coordinates
Bohrkoordinaten
cotes de perçage





a664 60 6057 ruthenium/blue

	small (lens former only)	large
 mm	57 x 33 (1581 mm ²)	59 x 34 (1694 mm ²)
 mm	60	62
 mm		18
 mm		135
 °		2 x 19

clip-on available (both sizes)
a526 00 a664 grey-green polarized

polarized

spare parts a664

- BC 606 temples
- GK 219 temple tips
- SR 270 K3 temple joint screw
- SP 92 GL nose pads
- STG 81 showing lens 8 base
- BLS 58 glazing pins
- PL 13 adidas cleaning cloth
- BA 833-7 lug



drilling coordinates
Bohrkoordinaten
cotes de perçage

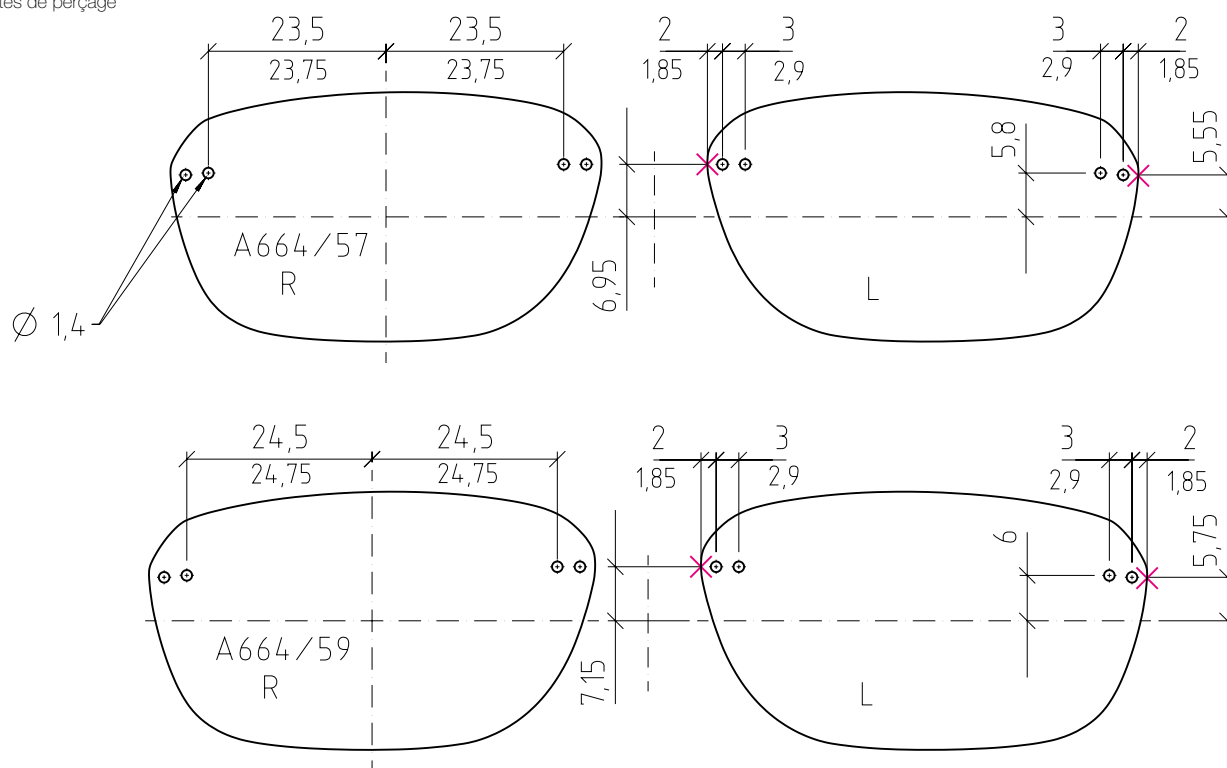

ambition

lens edge thickness



a661 00 6050 rhodium/lime



a662 50 6054 black/black

a661 - wrap tilt 19°

a662 - wrap tilt 19°

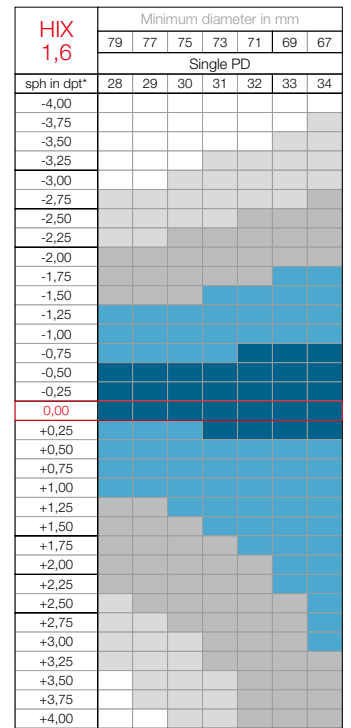
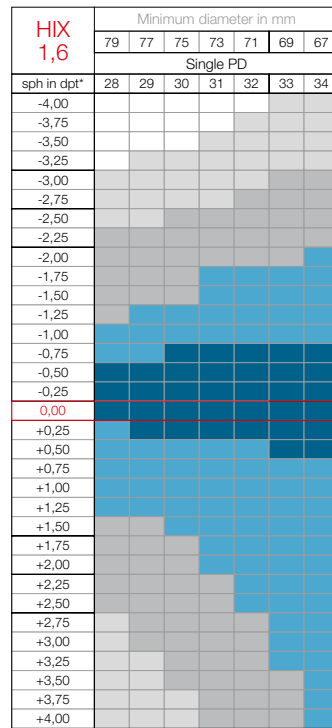
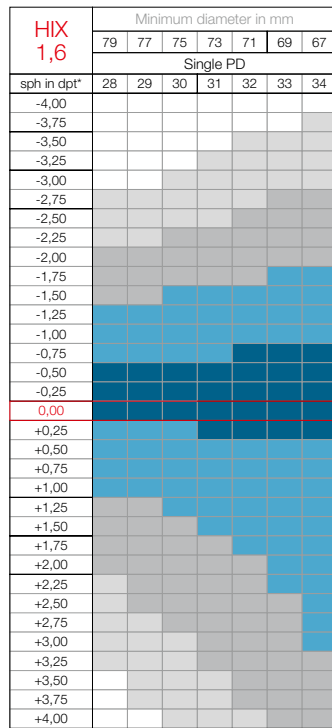
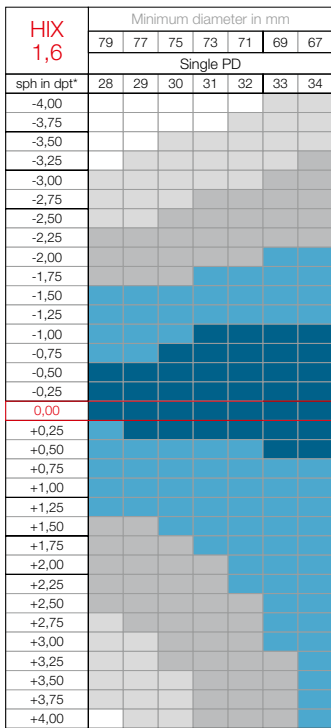

57-18

59-18

57-18

59-18

range of lens thickness

Bereich der Glasranddicke

gamme des épaisseurs de bordure de verre

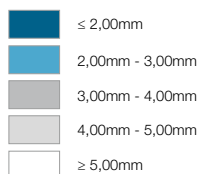

* stärkster Hauptschnitt

* power of the strongest principal meridian

* puissance de meridian principal le plus fort



ambition

lens edge thickness



a663 40 6053 chocolate/chocolate



a664 60 6057 ruthenium/blue

a663 - wrap tilt 19°

a664 - wrap tilt 19°

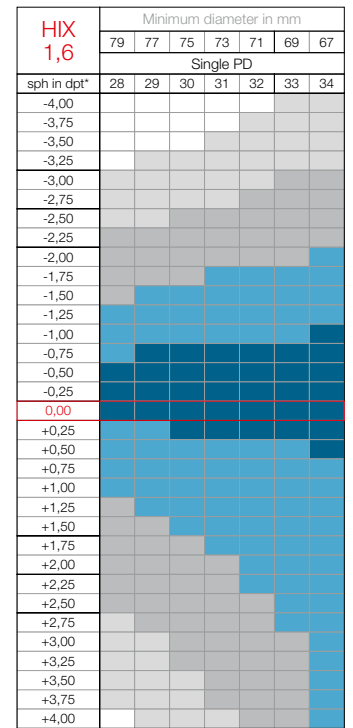
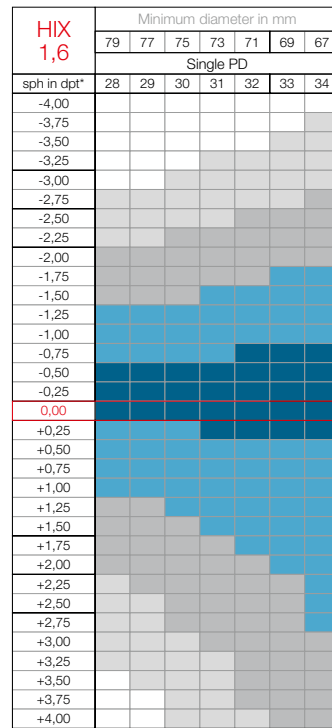
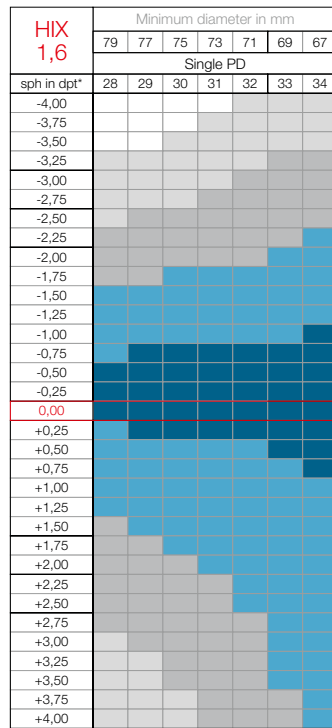
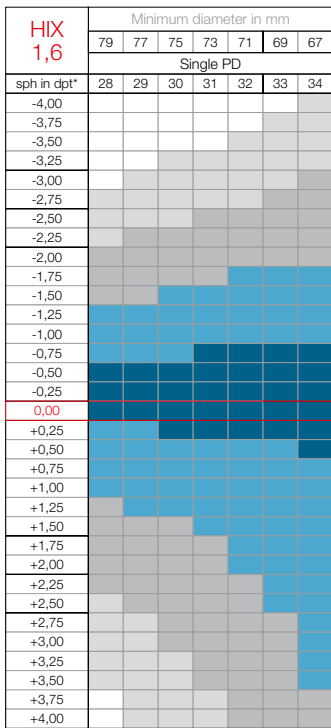

56-18

58-18

57-18

59-18

range of lens thickness

Bereich der Glasranddicke

gamme des épaisseurs de bordure de verre

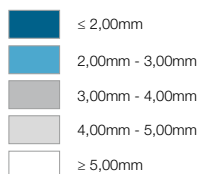

* stärkster Hauptschnitt

* power of the strongest principal meridian

* puissance de meridian principal le plus fort



